



User Manual



DIGITAL MONITOR SPEAKERS

MS40/MS20

24-Bit/192 kHz Digital 40/20-Watt Stereo Near Field Monitors

Table of Contents

Thank you	2
Important Safety Instructions	3
Legal Disclaimer	3
Limited Warranty	3
1. Introduction	4
1.1 Before getting started.....	4
1.1.1 Shipment.....	4
1.1.2 Initial operation	4
1.1.3 Online registration	4
2. Control Elements and Connections	4
3. Wiring	5
4. Specifications.....	6

Thank you

Thank you very much for expressing your confidence in us by purchasing the BEHRINGER DIGITAL MONITOR SPEAKERS MS20/MS40. The MS20/MS40 are active loudspeakers that reproduce your music with highest fidelity and balance. Due to their flexible connection options, the MS20/MS40 can be used in a variety of applications, such as computer studios and audio or multimedia workstations. You can also use them to monitor your keyboards and playback.

EN Important Safety Instructions

Terminals marked with this symbol carry electrical current of sufficient magnitude to constitute risk of electric shock.

Use only high-quality professional speaker cables with ¼" TS or twist-locking plugs pre-installed. All other installation or modification should be performed only by qualified personnel.



This symbol, wherever it appears, alerts you to the presence of uninsulated dangerous voltage inside the enclosure - voltage that may be sufficient to constitute a risk of shock.



This symbol, wherever it appears, alerts you to important operating and maintenance instructions in the accompanying literature. Please read the manual.

**Caution**

To reduce the risk of electric shock, do not remove the top cover (or the rear section). No user serviceable parts inside. Refer servicing to qualified personnel.

**Caution**

To reduce the risk of fire or electric shock, do not expose this appliance to rain and moisture. The apparatus shall not be exposed to dripping or splashing liquids and no objects filled with liquids, such as vases, shall be placed on the apparatus.

**Caution**

These service instructions are for use by qualified service personnel only. To reduce the risk of electric shock do not perform any servicing other than that contained in the operation instructions. Repairs have to be performed by qualified service personnel.

1. Read these instructions.
2. Keep these instructions.
3. Heed all warnings.
4. Follow all instructions.
5. Do not use this apparatus near water.
6. Clean only with dry cloth.
7. Do not block any ventilation openings. Install in accordance with the manufacturer's instructions.
8. Do not install near any heat sources such as radiators, heat registers, stoves, or other apparatus (including amplifiers) that produce heat.

9. Do not defeat the safety purpose of the polarized or grounding-type plug. A polarized plug has two blades with one wider than the other. A grounding-type plug has two blades and a third grounding prong. The wide blade or the third prong are provided for your safety. If the provided plug does not fit into your outlet, consult an electrician for replacement of the obsolete outlet.

10. Protect the power cord from being walked on or pinched particularly at plugs, convenience receptacles, and the point where they exit from the apparatus.

11. Use only attachments/accessories specified by the manufacturer.



12. Use only with the cart, stand, tripod, bracket, or table specified by the manufacturer, or sold with the apparatus. When a cart is used, use caution when moving the cart/apparatus combination to avoid

injury from tip-over.

13. Unplug this apparatus during lightning storms or when unused for long periods of time.

14. Refer all servicing to qualified service personnel. Servicing is required when the apparatus has been damaged in any way, such as power supply cord or plug is damaged, liquid has been spilled or objects have fallen into the apparatus, the apparatus has been exposed to rain or moisture, does not operate normally, or has been dropped.

15. The apparatus shall be connected to a MAINS socket outlet with a protective earthing connection.

16. Where the MAINS plug or an appliance coupler is used as the disconnect device, the disconnect device shall remain readily operable.



TO BIND MUSIC GROUP BY ANY EXPRESS OR IMPLIED UNDERTAKING OR REPRESENTATION. THIS MANUAL IS COPYRIGHTED. NO PART OF THIS MANUAL MAY BE REPRODUCED OR TRANSMITTED IN ANY FORM OR BY ANY MEANS, ELECTRONIC OR MECHANICAL, INCLUDING PHOTOCOPYING AND RECORDING OF ANY KIND, FOR ANY PURPOSE, WITHOUT THE EXPRESS WRITTEN PERMISSION OF MUSIC GROUP IP LTD.

ALL RIGHTS RESERVED.

© 2013 MUSIC Group IP Ltd.

Trident Chambers, Wickhams Cay, P.O. Box 146, Road Town, Tortola, British Virgin Islands

LIMITED WARRANTY

For the applicable warranty terms and conditions and additional information regarding MUSIC Group's Limited Warranty, please see complete details online at www.music-group.com/warranty.

LEGAL DISCLAIMER

TECHNICAL SPECIFICATIONS AND APPEARANCES ARE SUBJECT TO CHANGE WITHOUT NOTICE AND ACCURACY IS NOT GUARANTEED. BEHRINGER, KLARK TEKNIK, MIDAS, BUGERA, AND TURBOSOUND ARE PART OF THE MUSIC GROUP (MUSIC-GROUP.COM). ALL TRADEMARKS ARE THE PROPERTY OF THEIR RESPECTIVE OWNERS. MUSIC GROUP ACCEPTS NO LIABILITY FOR ANY LOSS WHICH MAY BE SUFFERED BY ANY PERSON WHO RELIES EITHER WHOLLY OR IN PART UPON ANY DESCRIPTION, PHOTOGRAPH OR STATEMENT CONTAINED HEREIN. COLORS AND SPECIFICATIONS MAY VARY FROM ACTUAL PRODUCT. MUSIC GROUP PRODUCTS ARE SOLD THROUGH AUTHORIZED FULLFILLERS AND RESELLERS ONLY. FULLFILLERS AND RESELLERS ARE NOT AGENTS OF MUSIC GROUP AND HAVE ABSOLUTELY NO AUTHORITY

1. Introduction

Two digital inputs plus two stereo analog inputs enable you to connect a broad range of sound sources and mix two of them within the loudspeakers. Additionally, we have equipped the MS20/MS40 with a headphone connector. The speakers are magnetically shielded, so you can use them near computer monitors.

- ◆ This User's Manual is intended to familiarize you with the unit's control elements, so that you can master all the functions. After having thoroughly read the user's manual, store it at a safe place for future reference.

1.1 Before getting started

1.1.1 Shipment

Your MS20/MS40 speakers were carefully packed at the assembly plant to assure secure transport. If the cardboard box is damaged, please inspect the equipment immediately for any signs of physical damage.

- ◆ NEVER send damaged units directly to BEHRINGER. Please, immediately notify the dealer from whom you acquired the unit and the transportation company that delivered the unit to you. Otherwise, all claims for replacement/repair may be rendered invalid.
- ◆ We recommend that you always use an appropriate carrying case when transporting your MS20/MS40 speakers to ensure their optimal protection.
- ◆ Always use the original packaging to avoid damage when shipping or storing the unit.
- ◆ Never let unsupervised children play with the MS20/MS40 or with its packaging.
- ◆ Please dispose of all packaging materials in an environmentally-friendly fashion.

1.1.2 Initial operation

Please make sure the unit is provided with sufficient ventilation, and never place the MS20/MS40 on top of an amplifier or in the vicinity of a heater to avoid the risk of overheating.

- ◆ Before plugging the unit into a power socket, please make sure that the voltage corresponds to the voltage stated on the label on the backside of your MS20/MS40.

Power is delivered via the cable enclosed with the unit. All required safety precautions have been adhered to.

ATTENTION!

- ◆ These monitor speakers are capable of producing extreme volumes. Please bear in mind that high sound pressures do not only temporarily damage your sense of hearing, they can also cause permanent damage. Be sure to select an appropriate volume level.

1.1.3 Online registration

Please register your new BEHRINGER equipment right after your purchase by visiting <http://behringer.com> and read the terms and conditions of our warranty carefully.

Should your BEHRINGER product malfunction, it is our intention to have it repaired as quickly as possible. To arrange for warranty service, please contact the BEHRINGER retailer from whom the equipment was purchased. Should your BEHRINGER dealer not be located in your vicinity, you may directly contact one of our subsidiaries. Corresponding contact information is included in the original equipment packaging (Global Contact Information/European Contact Information). Should your country not be listed, please contact the distributor nearest you. A list of distributors can be found in the support area of our website (<http://behringer.com>).

Registering your purchase and equipment with us helps us process your repair claims more quickly and efficiently.

Thank you for your cooperation!

2. Control Elements and Connections

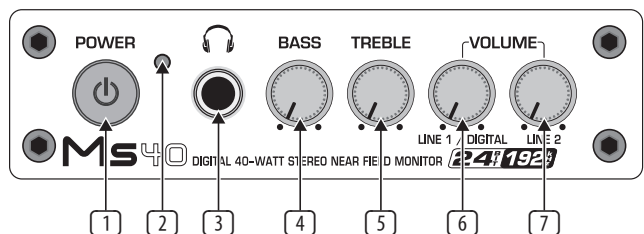

Fig. 2.1: Front panel elements (right loudspeaker)

- 1 Use the **POWER** switch to power up your MS20/MS40. The POWER switch should always be in the "Off" position when you are about to connect your unit to the mains.
 - ◆ Please note: The POWER switch does not fully disconnect the unit from the mains. To disconnect the unit from the mains, pull out the main cord plug or appliance coupler. Unplug the power cord when the unit is not used for prolonged periods of time.
 - ◆ Monitor speakers should be the last device in the signal chain to be switched on and the first to be switched off. This way, you avoid speaker damage caused by loud crackling noises during turning other equipment in your studio on or off.
 - 2 This LED lights up when power is switched on.
 - 3 Connect your headphones via the phones output (¼" TRS) to monitor any of the input devices. The internal speakers are automatically muted when headphones are connected to the unit.
 - 4 **BASS** control. Turn the bass control to adjust the bass level.
 - 5 **TREBLE** control. Turn the treble control to adjust the treble level.
- Turn the **VOLUME** controls 6 and 7 to adjust the overall volume levels of the devices connected to your MS20/MS40:
- 6 The **LINE 1 / DIGITAL** knob controls the volume level of the analog LINE 1 12 or the DIGITAL inputs 8 or 9.

7 Turn **LINE 2** control to adjust the volume level of LINE 2 input 13.

♦ **Attention: High volume levels may damage your hearing and/or your headphones. Please turn the VOLUME controls all the way to the left before powering up the unit. Be sure to always select an appropriate volume level.**

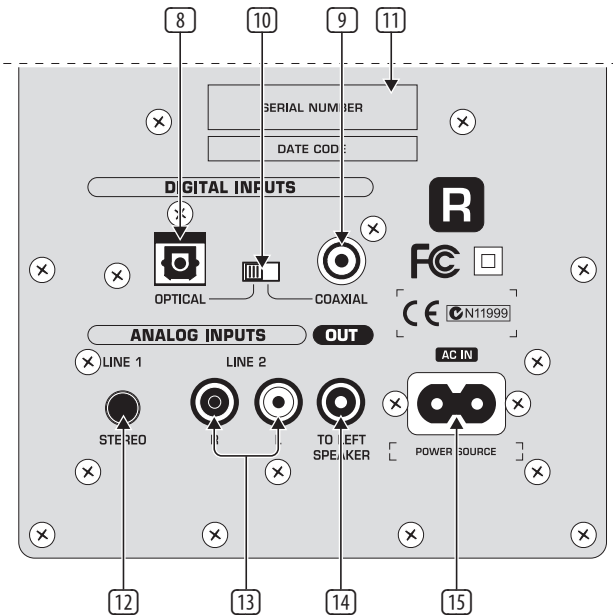

Fig. 2.2: Rear panel (right monitor)

- 8 Digital audio data can be fed in at the **OPTICAL** input.
- 9 The MS40 also features a digital **COAXIAL** input connector.
- 10 With this switch you can select the digital input (OPTICAL or COAXIAL).
- 11 **SERIAL NUMBER**.
- 12 Analog input **LINE 1** (1/8" TRS) allows you to connect stereo audio equipment such as CD/MD players.
- 13 Use the analog input **LINE 2** (RCA) to connect your sound card, keyboard or expander.
- ♦ **You can play back various signals by using both stereo inputs simultaneously.**
- 14 **TO LEFT SPEAKER** output connector. Connect both speakers by using the speaker cable included in this package. As soon as both speakers are properly connected, they will function as a stereo speaker system.
- 15 A standard power socket is provided for connection to the mains. A matching power cable is included with the unit. Before you connect the unit to the power source make sure that the power switch is turned off and the volume controls are turned all the way to the left to avoid any damage to speakers or other devices.

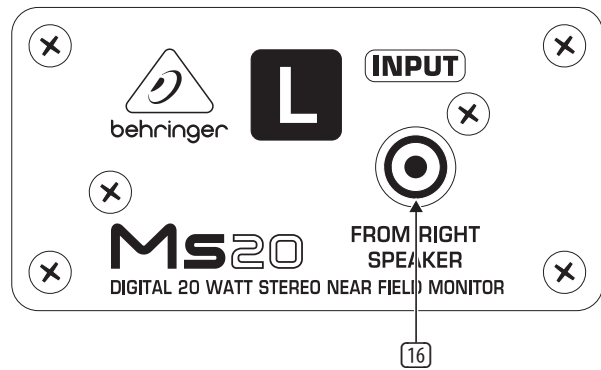

Fig. 2.3: Rear panel (left monitor)

16 **FROM RIGHT SPEAKER** connector. Insert the speaker cable from the **TO LEFT SPEAKER** connector.

3. Wiring

The DIGITAL MONITOR SPEAKERS MS20/MS40 are designed to accommodate a variety of connector types for almost any situation you may encounter.

You will find all audio inputs on the right speaker. The left speaker only has one audio input which is fed from the right speaker.

♦ **Be sure to mute the signal sources before you put the monitor speakers into operation.**

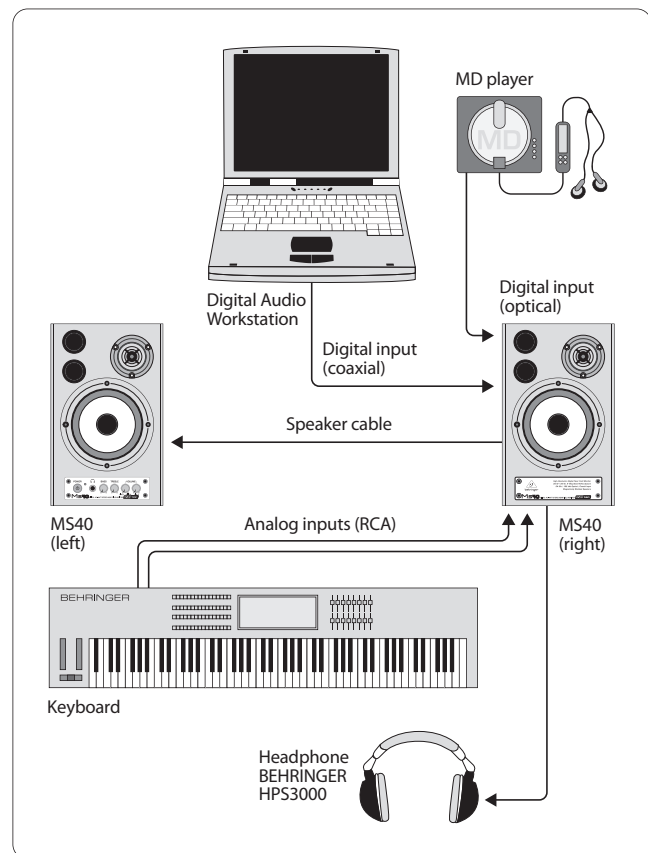

Fig. 3.1: Computer/keyboard setup

EN

Begin by connecting the left speaker to the right speaker by wiring the attached speaker cable from connector **14** to connector **16** on the left speaker.

Connect the analog outputs of your mixer, keyboard or computer sound card to **LINE 1** input **12**. Connect a second piece of equipment to **LINE 2** inputs **13**.

If you own equipment with digital connectors—such as CD or MD players—simply connect them to the digital inputs **8** and **9**. Select the digital signal you want to monitor with the input selector switch **10**.

You can mix two input signals within the MS20/MS40 by using the volume controls **6** and **7**. This enables you to monitor two different sound sources simultaneously. The above wiring example shows how you can monitor your live keyboard performance to a playback coming from your MD player or digital audio workstation (computer).

The MS20/MS40 speakers are shielded, which allows you to place them near your computer monitor without causing interference or damage. However, do not place your MS20/MS40 speakers near power amps. Doing so will result in an induced hum in your speakers.

4. Specifications

Loudspeakers

MS40

Tweeter	Ø 65 mm (2 1/2"), 8 Ω
Woofer	Ø 120 mm (4 3/4"), 4 Ω

MS20

Tweeter	Ø 65 mm (2 1/2"), 8 Ω
Woofer	Ø 92 mm (3 5/8"), 4 Ω

Audio Inputs

Line 1	1/8" TRS stereo, impedance 20 kΩ
Line 2	2 RCA, impedance 20 kΩ

Digital Inputs

Optical	TOSLINK
Coaxial	RCA
Converter	24-bit
Sample rate	< 192 kHz

System Specifications

MS40

Output power	2 x 20 W
Frequency response	50 Hz to 25 kHz

MS20

Output power	2 x 10 W
Frequency response	65 Hz to 25 kHz

Power Supply

Mains Voltages

USA/Canada	120 V~, 60 Hz
Europe/U.K./Australia	230 V~, 50 Hz
China	220 V~, 50 Hz
Japan	100 V~, 50 - 60 Hz
General export model	120/230 V~, 50 - 60 Hz

Power consumption

MS40:	90 W
MS20:	80 W

Physical

MS40

Dimensions (H x W x D)	11 x 6 4/5 x 9 5/8" 279 x 173 x 245 mm
Weight	right: 10.78 lbs / 4.9 kg left: 7.04 lbs / 3.2 kg

MS20

Dimensions (H x W x D)	9 3/5 x 6 x 7 3/8" 239 x 154 x 187 mm
Weight	right: 8.14 lbs / 3.7 kg left: 4.51 lbs / 2.05 kg

BEHRINGER is constantly striving to maintain the highest professional standards. As a result of these efforts, modifications may be made from time to time to existing products without prior notice. Specifications and appearance may differ from those listed or illustrated.

FEDERAL COMMUNICATIONS COMMISSION COMPLIANCE INFORMATION



Responsible Party Name: **MUSIC Group Services US Inc.**
Address: **18912 North Creek Parkway,
Suite 200 Bothell, WA 98011,
USA**
Phone/Fax No.: **Phone: +1 425 672 0816
Fax: +1 425 673 7647**

DIGITAL MONITOR SPEAKERS MS40/MS20

complies with the FCC rules as mentioned in the following paragraph:

This equipment has been tested and found to comply with the limits for a Class B digital device, pursuant to part 15 of the FCC Rules. These limits are designed to provide reasonable protection against harmful interference in a residential installation. This equipment generates, uses and can radiate radio frequency energy and, if not installed and used in accordance with the instructions, may cause harmful interference to radio communications. However, there is no guarantee that interference will not occur in a particular installation. If this equipment does cause harmful interference to radio or television reception, which can be determined by turning the equipment off and on, the user is encouraged to try to correct the interference by one or more of the following measures:

- Reorient or relocate the receiving antenna.
- Increase the separation between the equipment and receiver.
- Connect the equipment into an outlet on a circuit different from that to which the receiver is connected.
- Consult the dealer or an experienced radio/TV technician for help.

This device complies with Part 15 of the FCC rules. Operation is subject to the following two conditions:

- (1) this device may not cause harmful interference, and
- (2) this device must accept any interference received, including interference that may cause undesired operation.

Important information:

Changes or modifications to the equipment not expressly approved by MUSIC Group can void the user's authority to use the equipment.



We Hear You